

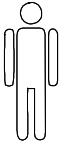

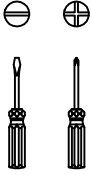
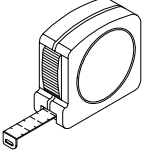
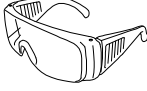

ASSEMBLY INSTRUCTIONS

01/05
EU034

 Warning –
CHOKING HAZARD – Small Parts Not for children under 3 years. Adult assembly required.

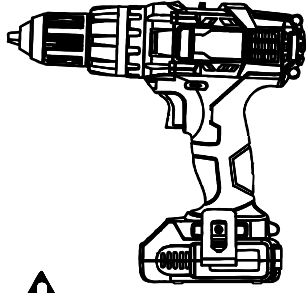
				 30mins	  Although not required, it is recommended that a drill be used to help ease the assembly process, as some holes are not pre-drilled.
---	---	---	---	--	---

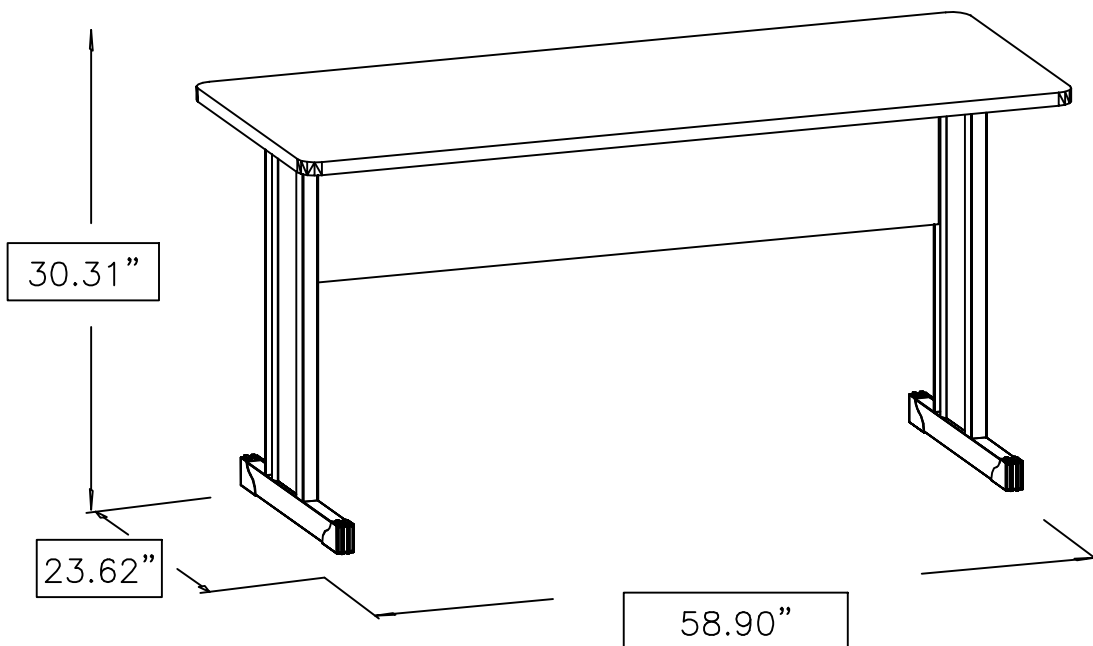

List of pieces						
Code	Description	Amount	Length (in.)	Width (in.)	Thickness (in.)	Box
01	Top panel	1	58.90"	23.62"	.98"	A
02	Reinforcement	1	49.76"	14.09"	.59"	A
03	Foot centerpiece	2	26.57"	5.04"	.59"	A

For issues with ASSEMBLY or PARTS please contact CS@k1intlgrp.com or Toll-free 1-877-250-2820.

Part Identification

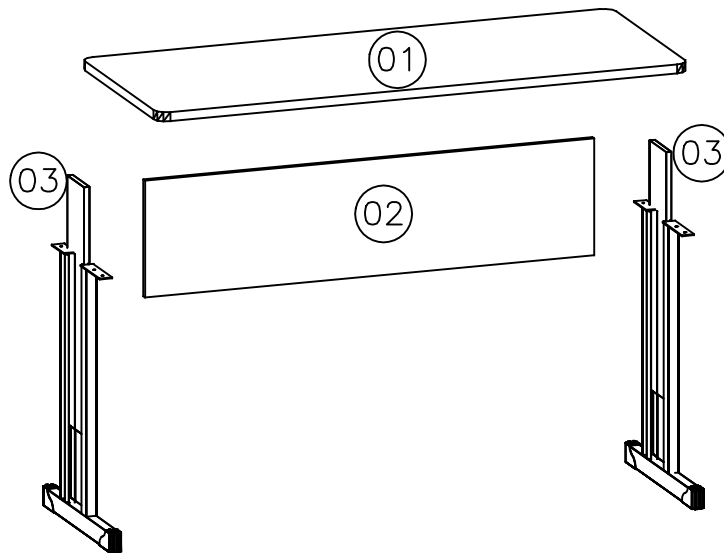



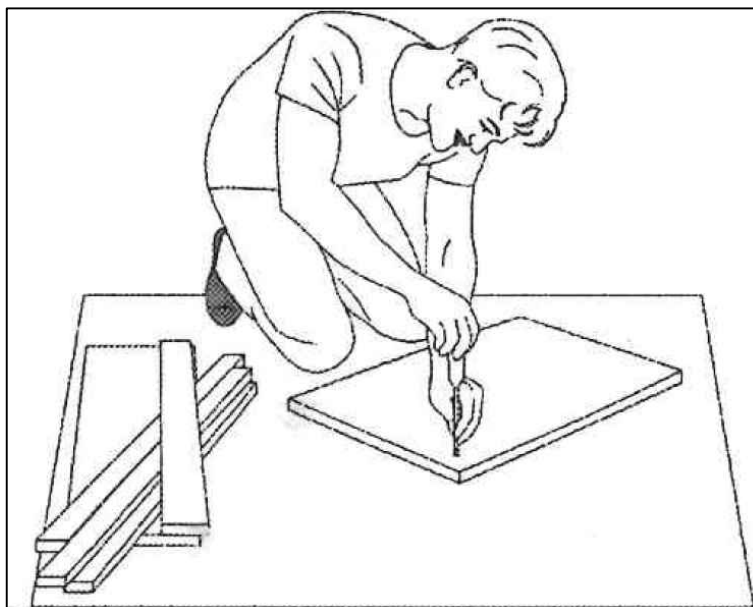

It is recommended the use of the box in which your furniture arrived in, be opened, and laid out on the floor as your work area. This helps prevent an unnecessary damages from occurring.

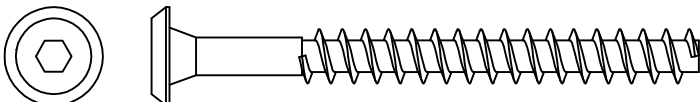

T
O
S
C
A
L
E

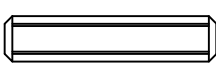
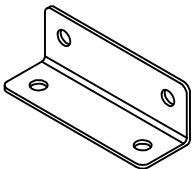
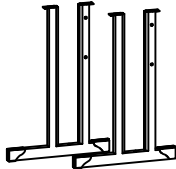

N
O
T
O
T
O
S
C
A
L
E

Hardware			
	Code	Description	Amou.
A	1260	 Structural Screw 7x70	4
B	4214	 Screw 3,5x14	16
C	1802	 Dowel 6x30mm	2
D	899	 Metal angle bracket	2
E	55878	 Set of feet	2
G	BR=4430 (Cinza)	 Cover CPL	4
H	248	 Allen key 1/4"	1
01 Saco pequeno para acessórios (Internal production data)			



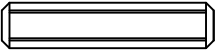

1

Preassembly of parts

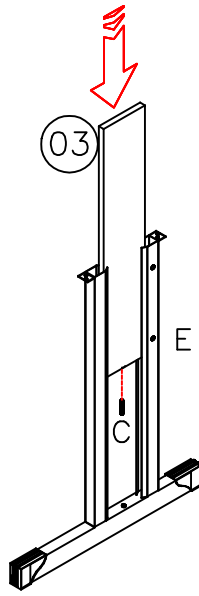
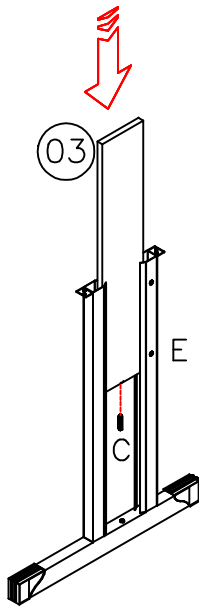
C		2
E		2

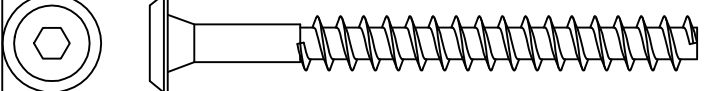

2

A		4
H		1
G		4

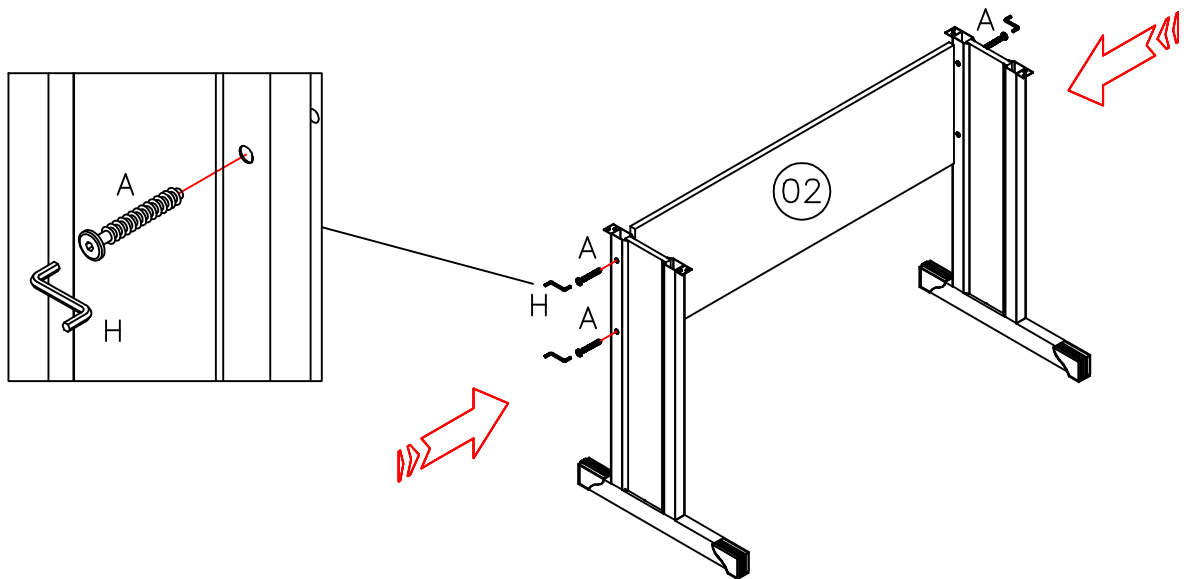

3

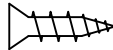
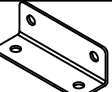
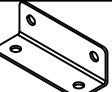
B			16
D			2

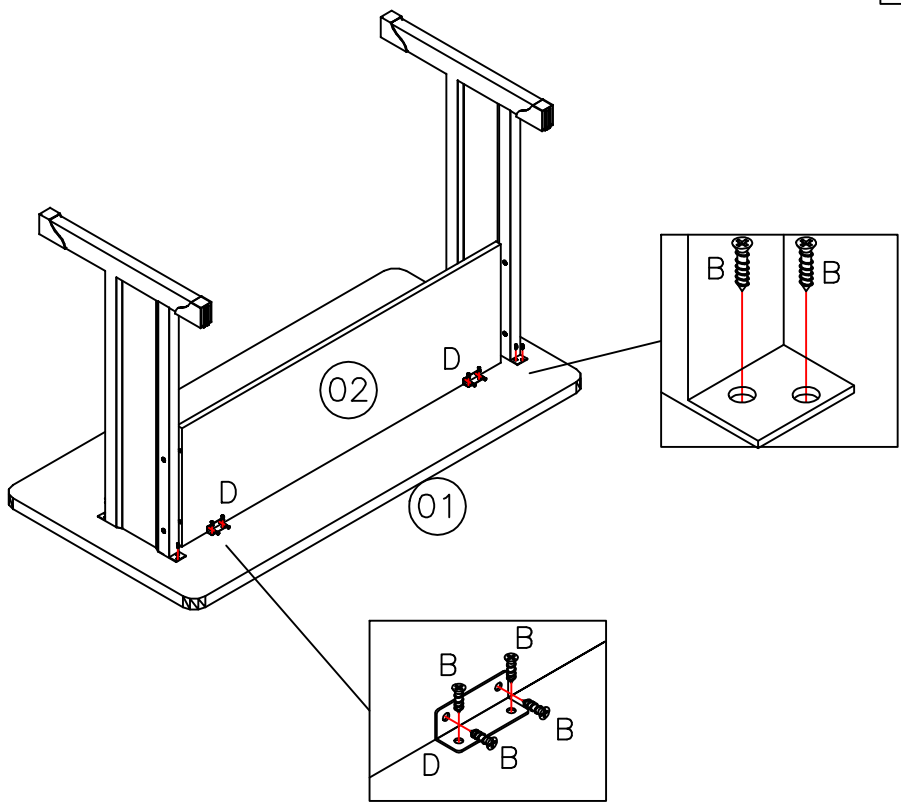

4

